

CPUZ2919-D10 Chef Pro Sink



Model: CPUZ2919-D10

Dimensions

- Interior: 27" x 17" x 10"
- Overall: 29" x 19" x 10"

Color/Finish

- Stainless Steel

Features

- Handmade
- 10" deep single bowl
- 16 gauge 304 stainless steel finish
- 18/10 Nickel/Chrome content
- Long lasting tight brush finish
- Tapered front arched apron design
- Stain and corrosion resistant
- V-Therm Shield™ undersurface
- Undermount

Optional Accessories

- Sink Strainer
- Grid

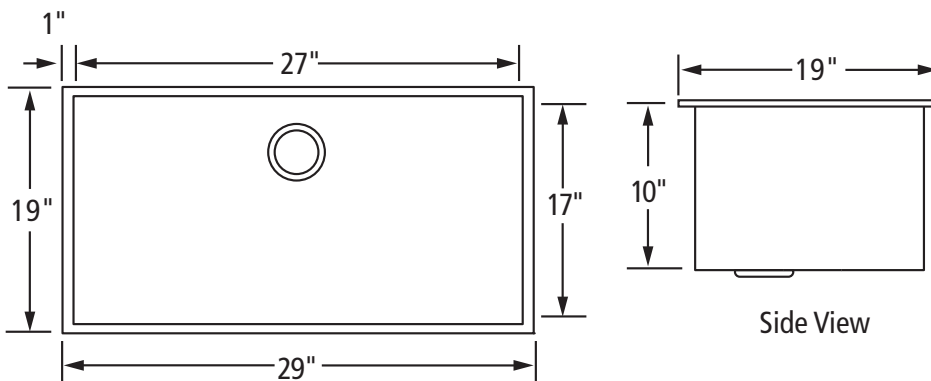

All sinks are handmade. Prior to cutting, verify with included template.